



IMPRESSA E80/85

Instructions for use



I
M
P
R
E
S
S
A

JURA IMPRESSA E80/85

Legend:

- **DISPLAY** DISPLAY: serves as information.
- **DISPLAY** **DISPLAY**: please follow the instructions shown.

 = Note

 = Important

 = Tip

JURA Elektroapparate AG, CH-4626 Niederbuchsiten,
Internet <http://www.jura.com>



Fig. 1



Fig. 2



Fig. 3



Fig. 4



Fig. 5



Fig. 6



Fig. 7



Fig. 8

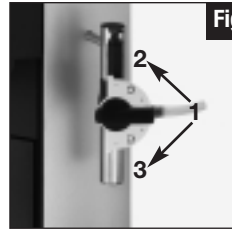

Fig. 9



Fig. 10

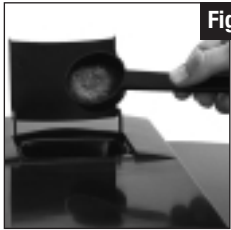

Fig. 11



Fig. 12

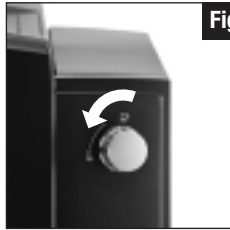

Fig. 13



Fig. 14



Fig. 15

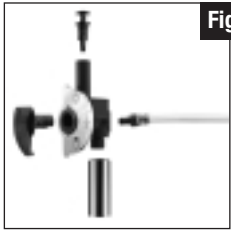

Fig. 16



Fig. 17

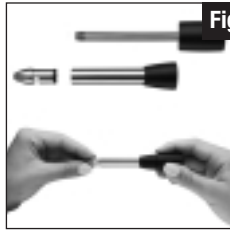
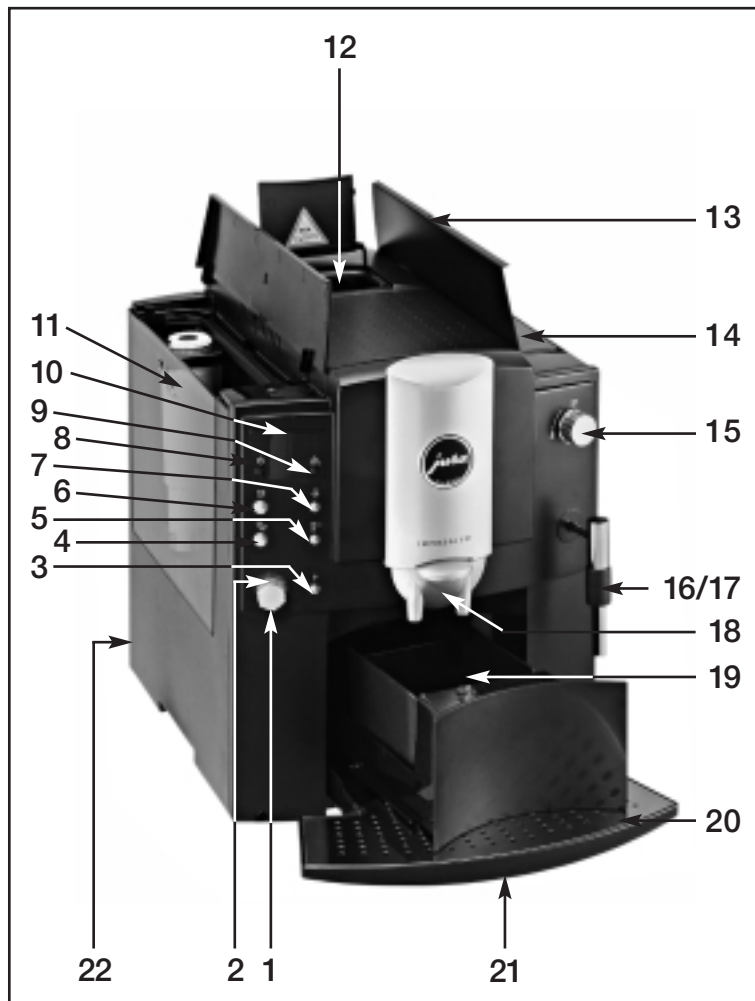

Fig. 18



Control elements

1. Rotary Switch
2. Illuminated ring
3. Programming key
4. Draw-off key 2 cups
5. Powder coffee selection key
6. Draw-off key 1cup
7. Steam pre-selection key
8. ON/OFF key
9. Maintenance key
10. Display dialog system
11. Water tank with carrying handle
12. Filler funnel for pre-ground coffee
13. Bean tank cover
14. Aroma preservation cover
15. Steam/hot water water draw-off valve
16. Replaceable 2-stage frothing jet see fig.6
17. Replaceable hot water jet mounted in illustration also see Fig. 5
18. Height-adjustable coffee spout
19. Coffee grounds container
20. Drip grate
21. Drip drawer
22. Power Switch

Contents

JURA IMPRESSA E80/85

1. Safety information.....	page 6	14. Switching off the IMPRESSA E80/85	page 14
1.1 Warning.....	page 6	15. Programming	page 14
1.2 Precautions.....	page 6	15.1 Programming the filter	page 15
2. Preparing the IMPRESSA E80/85.....	page 6	15.2 Programming the water hardness	page 15
2.1 Check supply voltage.....	page 6	15.3 Programming the aroma STANDARD or ROBUST	page 15
2.2 Check electrical fuse	page 6	15.4 Programming the automatic switch-on time	page 15
2.3 Fill water tank.....	page 7	15.5 Cup counter	page 16
2.4 Fill coffee beans.....	page 7	15.6 Programming the language.....	page 16
2.5 Adjusting the grinding gear	page 7	15.7 Milliliters/Ounces	page 16
2.6 Power switch.....	page 7	15.8 Switch-off rinsing operation.....	page 17
3. First use.....	page 7	16. Maintenance	page 17
4. Adjusting the water hardness	page 8	16.1 Filling in water	page 17
5. Installation of CLARIS plus filter cartridges	page 9	16.2 Emptying the coffee grounds container	page 17
5.1 Installing the filter	page 9	16.3 Drawer missing.....	page 17
5.2 Replacing the filter upon display request.....	page 9	16.4 Fill coffee beans.....	page 17
5.3 Replacing the filter without display request.....	page 10	16.5 Replacing the filter.....	page 18
6. IMPRESSA E80/85 rinsing upon display request ..	page 10	16.6 General cleaning instructions	page 18
6.1 IMPRESSA E80/85 rinsing without display request.....	page 10	16.7 Emptying the system	page 18
7. Adjusting the water quantity for coffee.....	page 10	17. Cleaning the IMPRESSA E80/85 upon display request.....	page 18
8. Drawing off 1 cup of coffee	page 11	17.1 Cleaning the IMPRESSA E80/85 without display request.....	page 19
9. Drawing off 2 cups of coffee	page 11	18. De-scaling the IMPRESSA E80/85 upon display request.....	page 19
10. Drawing off pre-ground coffee	page 12	18.1 De-scaling the IMPRESSA E80/85 without display request	page 20
11. Drawing off hot water	page 12	19. Disposal	page 21
12. Drawing off steam	page 13	20. Tips for perfect coffee	page 21
13. Drawing off steam using the Professional Cappuccino Frother (optional)	page 13	21. Messages.....	page 22
13.1 Connecting the Professional Cappuccino Frother to your IMPRESSA E80/85.....	page 14	22. Problems.....	page 23
13.2 Drawing off cappuccino and hot milk using the Professional Cappuccino Frother	page 14	23. Legal information.....	page 24
13.3 Cleaning the Professional Cappuccino Frother	page 14	24. Technical Data.....	page 24

Introduction

Thank you for purchasing the IMPRESSA E80/85. To ensure perfect functioning of your IMPRESSA E80/85, carefully read this operating manual and keep it for future reference.

Should you need more information or if you encounter particular problems not specified in these operating instructions in sufficient detail, either contact us directly or contact your local authorized dealer.



You will also find useful tips on operation and maintenance of your IMPRESSA E80/85 on the website at www.jura.com. Don't forget to check out the Knowledge Builder our animated operating instructions. LEO, our assistant, will take you through all the functions.

1. Safety information

1.1 Warning

- Children do not realize the dangers involved in using electric appliances, for this reason always keep an eye on children when they use electric appliances.
- The coffee machine may only be used by instructed persons.
- Never use a defective coffee machine or a machine with a defective mains cable.
- Never repair or open the coffee machine yourself. Any repairs may only be carried out by authorized service shops using original spare parts and accessories.
- Never immerse the coffee machine in water.

1.2 Precautions

- Never expose the coffee machine to weather (rain, snow, frost), never touch the machine when your hands are wet.
- Place the IMPRESSA on a firm, level base that is resistant to any water that may leak. Never stand on hot or warm surfaces (oven hobs). Keep out of the reach of children.
- If you don't use the machine for a longer time (holidays, etc.) always disconnect the mains cable.
- Always disconnect mains cable before cleaning the machine.
- When disconnecting the mains cable never pull on the mains cable or the machine itself.
- The coffee machine is connected to mains supply via a mains cable. Make sure nobody can trip over the mains cable. Make sure children and pets cannot reach the machine
- Never put the coffee machine or individual parts of it into a dishwasher.
- Make sure to install the machine at a place with sufficient air circulation, to prevent overheating of the machine.

2. Preparing the IMPRESSA E80/85

2.1 Check supply voltage

The IMPRESSA E80/85 is preset in the factory to the correct mains voltage. Check if your local mains supply voltage complies with the information given on the type plate on the underside of the IMPRESSA E80/85.

2.2 Check electrical fuse

The IMPRESSA E80/85 is designed for an electric current of 10 amperes. Check if the electrical fuse has sufficient capacity.

2.3 Fill water tank

 Only use fresh, cold water. Never fill in milk, mineral water or other liquids.

- Remove the water tank and rinse it with cold tap water thoroughly (Fig. 4).
- Then fill the water tank and reinstall it. Make sure to install the tank properly, it must engage audibly.

2.4 Fill coffee beans

 To ensure that your machine will work perfectly for a long time and to avoid damage, please note that the grinding gear of your JURA coffee machine is not suitable for coffee beans which were treated, during or after roasting, with additives (e.g. sugar). Such coffee blends may damage the grinding gear. Any repair costs resulting from the use of such blends are not covered by warranty.

- Open the bean tank cover (13) and remove the aroma preservation cover (14).
- Remove any dirt or foreign matter from the bean tank.
- Fill coffee beans in the bean tank and close the cover.

2.5 Adjusting the grinding gear

You can adjust the grinding gear to the roast of your coffee. We recommend

- a fine grinding degree → for bright roasts (the smaller the dots, the finer the grinding)
- a coarse degree → for dark roasts (the larger the dots, the coarser the grinding)

 The grinding degree may only be adjusted while the grinding gear is running.

- Open the bean tank cover (13) and remove the aroma preservation cover (14).
- To adjust the grinding degree, turn the Rotary Switch (Fig. 2) to the required position.

2.6 Power switch

 Actuate the power switch (22) on your IMPRESSA E80/85 before using the machine for the first time.

 We recommend that you switch off your IMPRESSA E80/85 with the power switch (22) if you intend not to use the machine for longer periods of time (e.g. during holidays)

3. First use

 Upon first commissioning or after a service, the system needs to be filled. The system filling operation works properly only if NO CLARIS plus filter is inserted. Please do not insert it before the system is filled and **DISPLAY** READY is displayed.

- Fill coffee beans in the bean tank (13).
- Switch on the IMPRESSA E80/85 using the ON/OFF key  (8).
- **DISPLAY** SPRACHE
DEUTSCH
- The illuminated ring (2) is active.
- Turn the Rotary Switch (1) until the required language is displayed.
- For example **DISPLAY** LANGUAGE
ENGLISH
- Confirm your selection by pressing the Rotary Switch (1).
- **DISPLAY** FILL
WATER

- Fill the water tank (11) with fresh water.
- **DISPLAY** OPEN TAP
- Place an empty cup under the replaceable hot water nozzle (17).
- Open the steam / hot water draw-off tap (15) (Fig. 13).
- **DISPLAY** FILLING SYSTEM
- **DISPLAY** SHUT TAP
- Close the steam / hot water draw-off tap (15).
- **DISPLAY** HEATING
- **DISPLAY** PRESS RINSE
- Press the maintenance key  (9).
- Machine carries out a rinsing operation.
- **DISPLAY** RINSING
- **DISPLAY** READY

 If BEANS FILL is displayed, press the coffee draw-off key again. Machine not filled with coffee beans yet.

 To get an excellent froth, adjust the coffee spout (18) to the size of your cup (Fig. 3).

4. Adjusting the water hardness

 Water is heated in the IMPRESSA E80/85. As a result, calcification occurs during normal use and is indicated automatically. Before using the IMPRESSA E80/85 for the first time the hardness of the water used must be adjusted. Use the supplied test sticks for this.

 1° German hardness is equivalent to 1.79° French hardness.

 If the filter is activated, the program step Water Hardness no longer appears.

 The IMPRESSA E80/85 has 5 hardness degrees which can be used and are displayed while you are adjusting the water hardness.

The displayed information means the following:

LEVEL — Water hardness function switched off

LEVEL 1 German water hardness degree 1 to 7°
French Water hardness degree 1.79 – 12.53°

LEVEL 2 German water hardness degree 8 to 15°
French Water hardness degree 14.32 – 26.85°

LEVEL 3 German water hardness degree 16 to 23°
French Water hardness degree 28.64 – 41.14°

LEVEL 4 German water hardness degree 24 to 30°
French Water hardness degree 42.96 – 53.7°

When the IMPRESSA E80/85 leaves the factory it is adjusted to LEVEL 3. You can adjust another hardness. To do this, proceed as follows:

- **DISPLAY** READY
- Press the programming key  (3).
- Illuminated ring (2) is active.
- **DISPLAY** FILTER –
- Turn the Rotary Switch (1) until the following message is displayed:
- **DISPLAY** HARDNESS
- Now press the Rotary Switch (1) to start the programming.
- **DISPLAY** LEVEL 3
- Turn the Rotary Switch (1) until the required level is displayed.
- For example, **DISPLAY** LEVEL 4

- Press the Rotary Switch (1) to confirm the required level.
- **DISPLAY** HARDNESS
- Press the programming key  (3) to quit the programming mode.
- **DISPLAY** READY

5. Installation of CLARIS plus filter cartridges

 If the CLARIS plus filter cartridge is installed properly, de-scaling of the coffee machine is no longer required. For more information on the CLARIS plus filter cartridge refer to brochure «CLARIS plus. Hard on limescale. Gentle on your coffee machine.»



5.1 Installing the filter

- Fold up the cartridge holder. Install the filter cartridge in the water tank (11), applying a gentle pressure (Fig. 1).
- Fold down the cartridge holder again until it engages audibly.
- Fill the water tank (11) with cold, fresh tap water and install it again.
- Press the programming key  (3), the illuminated ring (2) is active.
- **DISPLAY** FILTER –
- Press the Rotary Switch (1) to start the programming.
- **DISPLAY** NO –
- Turn the Rotary Switch (1) until the following message is displayed:
- **DISPLAY** YES ✓
- Press the Rotary Switch (1) to activate the filter cartridge.
- **DISPLAY** INSERT
OPEN TAP

- Put a sufficiently large container (approx. 1 litre) under the replaceable hot water nozzle (17).
- If not installed already, insert the CLARIS plus filter.
- Open the steam / hot water draw-off valve (15) (Fig. 13)
- **DISPLAY** RINSING
FILTER
- **DISPLAY** SHUT TAP
- Close the steam/hot water draw-off valve (15), now the IMPRESSA E80/85 will heat up to coffee temperature.
- **DISPLAY** HEATING
- **DISPLAY** READY

 Now you have activated the filter. In Programming Mode the water hardness selection function is no longer displayed.

5.2 Replacing the filter upon display request

-  After drawing off 50 liters of water the filter cartridge will be used up. A message requesting you to replace the filter will appear on the display
- **DISPLAY** CHANGE FILTER / MACHINE READY
- Press the maintenance key  (9).
- **DISPLAY** REPLACE
OPEN TAP
- Remove the water tank (11) from the machine and empty it.
- Fold up the cartridge holder. Install the filter cartridge in the water tank (11), applying a gentle pressure (Fig. 1).
- Fold down the cartridge holder again until it engages audibly.
- Fill the water tank (11) with cold, fresh tap water and reinstall it.
- Place a sufficiently large jug (approx. 1 litre) under the replaceable hot water nozzle (17) and open the steam/hot water tap (15) (Fig. 13).

- **DISPLAY** RINSING
FILTER
- **DISPLAY** SHUT TAP
- Close the steam / hot water draw-off tap (15).
- **DISPLAY** HEATING
- **DISPLAY** READY

5.3 Replacing the filter without display request

Rinsing, cleaning, de-scaling and filter replacement can also be started without the corresponding request of your IMPRESSA E80/85, if necessary, directly from the maintenance menu.

- Press the maintenance key  (9) until **DISPLAY** RINSING is displayed
- Turn the Rotary Switch (1) until **DISPLAY** FILTER is displayed
- Press the Rotary Switch (1)
- Now the program “Replacing the filter” is activated. Now, proceed as described in Chapter 5.2 as from **DISPLAY** REPLACE OPEN TAP

6. IMPRESSA E80/85 rinsing upon display request

 When the IMPRESSA E80/85 was switched off and has cooled down in the meantime, a rinsing operation is started when the machine is switched on again. When the machine is switched off, a rinsing operation is started automatically.

- Switch on the IMPRESSA E80/85 using the ON/OFF key  (8).
- **DISPLAY** HEATING
- **DISPLAY** PRESS
RINSE



- Press the maintenance key  (9).
- **DISPLAY** RINSE
- **DISPLAY** READY

6.1 IMPRESSA E80/85 rinsing without display request

- Press the maintenance key  (9) until **DISPLAY** RINSE is displayed
- Press the Rotary Switch (1)
- **DISPLAY** RINSE

7. Adjusting the water quantity for coffee

 The indicated value in ML/OZ is a reference value and may deviate from the actual value



 If you press the draw-off key for 2 cups  (4) the water quantity is doubled automatically.

 You can change/stop the water quantity during the draw-off operation, too. Turn the Rotary Switch (1) until the required ML value is displayed.

You can adjust the water quantity in steps of 5 ML using the Rotary Switch (1).



- **DISPLAY** READY
- Turn the Rotary Switch (1) until the required water quantity is displayed.
- For example, **DISPLAY** 120 ML

8. Drawing off 1 cup of coffee

 You can increase the strength of your coffee at any time during the grinding operation by pressing the 1 cup  draw-off key again.

For Example: Press the 1 cup  draw-off key three times to get a strong coffee

DISPLAY STRONG

 You can choose among three strengths at the push of a button. The longer you press the draw-off key for 1 cup  (6), the stronger your coffee will be (**DISPLAY** MILD / NORMAL / STRONG)

 You can adjust the water quantity before the draw-off operation using the Rotary Switch (1).

 You can stop the draw-off operation at any time by pressing any coffee draw-off key.

 You can check the water quantity used for the last draw-off operation by pressing the Rotary Switch (1).

■ **DISPLAY** READY

■ Put a cup under the adjustable coffee spout (18).

■ Press the draw-off key for 1 cup  (6) until the required strength is displayed:

■ For Example: **DISPLAY** MILD

■ **DISPLAY** 180 ML (water quantity last adjusted)

■ The illuminated ring (2) is active.

■ Turn the Rotary Switch (1) again to select the water quantity individually:

■ For Example: **DISPLAY** 160 ML

■ For Example: **DISPLAY** MILD

■ Your product is being prepared.

■ **DISPLAY** READY

9. Drawing off 2 cups of coffee

 Selecting the coffee strength is not possible when drawing off 2 cups of coffee. You will draw off 2 mild cups automatically.

 You can adjust the water quantity before the draw-off operation using the Rotary Switch (1). The adjusted value (ML) refers to 1 cup.

 You can stop the draw-off operation at any time by pressing any coffee draw-off key.

 You can check the water quantity used for the last draw-off operation by pressing Rotary Switches (1).

■ **DISPLAY** READY

■ Put 2 cups under the adjustable coffee spout (18).

■ Press the draw-off key for 2 cups  (4).

■ **DISPLAY** 2 CUPS

■ **DISPLAY** 120 ML (water quantity last adjusted)

■ The illuminated ring (2) is active.

■ Turn the Rotary Switch (1) again to select the water quantity individually:

■ For Example: **DISPLAY** 210 ML

■ **DISPLAY** 2 CUPS

■ Your product is being prepared.

■ **DISPLAY** READY

10. Drawing off pre-ground coffee

 Never use instant coffee or quick-coffee. We recommend that you always use powder from fresh coffee beans or, pre-ground, vacuum-packed coffee. Never fill in more than 2 portions of powder. The pre-ground coffee tank is no storage tank. Make sure that the pre-ground you use is not too fine. This may cause blocking of the system. In this case the coffee only drips out of the coffee spout.



 If you have filled in too little powder, the message NOT ENOUGH POWDER will be displayed. The IMPRESSA E80/85 stops the operation and returns to "ready for draw off" mode.

 You can stop the draw-off operation at any time by pressing any coffee draw-off key.

■ **DISPLAY** READY

- Put 1 or 2 cups under the adjustable coffee spout (18).
- Open the cover of the filler funnel for pre-ground coffee (12).
- Press the powder coffee selection key (5).

■ **DISPLAY** FILL
POWDER

- Fill 1 or 2 level spoonfuls of pre-ground coffee in the filler funnel for pre-ground coffee (12) (Fig. 11) and close the cover.
- Press the required draw-off key for 1 cup  (6) or 2 cups  (4)
- **DISPLAY** 120 ML (water quantity last adjusted)
- The illuminated ring (2) is active.
- **DISPLAY** POWDER
- Turn the Rotary Switch (1) again to select the water quantity individually:
- For Example: **DISPLAY** 210 ML

■ **DISPLAY** POWDER

■ Your product is being prepared.

■ **DISPLAY** READY

11. Drawing off hot water

 If you do not change the settings using the Rotary Switch (1), the water quantity last adjusted will be drawn off automatically.

 Install the hot water jet (see Fig. 5) to obtain perfect water flow. Do not replace the replaceable hot water jet (17) directly after drawing off water, because the nozzle is hot after the draw-off operation.

 At the start of the water draw-off operation there can be splashing. Avoid direct contact with the skin!

■ **DISPLAY** READY

- Place a cup under the replaceable hot water jet (17).
- Open the steam / hot water draw-off tap (15) (Fig. 13).
- The illuminated ring (2) is active.
- For example: **DISPLAY** 140 ML

■ **DISPLAY** WATER

■ Adjust the required water quantity by turning the Rotary Switch (1).

■ For example: **DISPLAY** 200 ML

■ **DISPLAY** WATER

■ If the required water quantity is reached, the following message is displayed:

■ **DISPLAY** SHUT TAP

■ Close the steam / hot water draw-off tap (15).

■ **DISPLAY** READY

 Before CLOSE TAP water may still escape the system.

12. Drawing off steam

 To ensure perfect operation, clean the 2-stage frothing jet (16) regularly. Screw the jet off as described. Hold the jet at the top and at the bottom end and screw it apart (Fig. 18). Thoroughly rinse the 3 parts under running water.

 Make sure the nozzle has engaged properly. If the nozzle is clogged with dried milk or has not been attached properly, it might suddenly come off during operation.

 Install the replaceable 2-stage frothing jet (Fig. 6). This is included in your Welcome Pack. Do not replace the replaceable steam/hot water jet (16) directly after drawing off steam, because the jet is hot after the draw-off operation.

 Steam can be used for heating liquids and frothing milk for cappuccino. Make sure that the replaceable steam/frothing jet (16) is pushed upwards when liquids are heated. To froth liquids, push the 2-stage frothing jet downwards, turning it slightly.

 During frothing some water will escape the system before the actual frothing process. This does not affect the result, e.g. when frothing milk.

 At the start of the steam draw-off operation there can be splashing! The steam jet becomes hot. Avoid direct contact with the skin!

■ **DISPLAY** READY

■ Place a cup under the 2-stage frothing jet (16) and immerse it in the milk to be frothed or the liquid to be heated.

■ Press the steam pre-selection key  (7).

■ **DISPLAY** HEATING

■ **DISPLAY** STEAM

■ To draw off steam, open the steam/hot water draw-off tap (15) (Fig. 13).

■ The illuminated ring (2) is active.

■ You can adjust the steam draw-off time individually by turning the Rotary Switch (1) until the required SEC are displayed.

■ For example, **DISPLAY** 35 SEC

■ If you do not change the steam draw-off time settings using the Rotary Switch (1), the machine will use the settings last adjusted



■ During the steam draw-off operation, the message STEAM is displayed

■ When the steam quantity is reached, the message SHUT TAP is displayed

■ Close the steam / hot water draw-off tap (15).

■ **DISPLAY** READY

 Before SHUT TAP, steam may still escape the system.

 The machine is ready for steam draw-off for 40 seconds, i.e. within this period you can draw off steam, stop the operation and activate it again without having to heat the machine up again. When the time has expired, press the steam pre-selection key  (7) again.

13. Drawing off steam using the Professional Cappuccino Frother (option)

 The Professional Cappuccino Frother is optionally available. Contact your authorized dealer.

13.1 Connecting the Professional Cappuccino Frother to your IMPRESSA E80/85

- Disassemble the replaceable hot water jet (Fig. 5) or the replaceable 2-stage frothing jet (Fig. 6).
- Mount the Professional Cappuccino Frother (Fig. 7)
- Press one side of the hose into the opening behind the dial (Fig. 10)



The optionally available milk container can be used for sucking in milk. How to connect it (see Fig. 8).

13.2 Drawing off cappuccino and hot milk using Professional Cappuccino Frother

- Fill the milk container with milk or immerse the hose in the milk directly.
- Place a cup under the Professional Cappuccino Frother (Fig. 8)
- Press the steam pre-selection key  (7).
- **DISPLAY** HEATING
- **DISPLAY** STEAM
- To draw off steam open the steam/hot water draw-off valve (15) (Fig. 13).
- The illuminated ring (2) is active.
- You can adjust the steam draw-off time individually but turning the Rotary Switch (1) until the required SEC are displayed.
- For example: **DISPLAY** 35 SEC
- If you do not change the steam draw-off time settings using the Rotary Switch (1), the machine will use the settings last adjusted
- For cappuccino turn the selector switch (1) (Fig. 9) to area (2)
- For hot milk turn the selector switch (1) (Fig. 9) to area (3)
- Now place the cup with the cappuccino froth or the hot milk under the coffee spout and draw of the product of your choice.

13.3 Cleaning the Professional Cappuccino Frother



The Professional Cappuccino Frother must be cleaned after each draw-off operation.

- Fill water in a container and immerse the hose in it.
- Draw off steam until the water/steam mixture is clean.
- If necessary, disassemble the Professional Cappuccino Frother and thoroughly rinse the flow regulation with water (Fig. 16 and Fig. 17)



For proper cleaning, use the JURA Auto Cappuccino Cleaning Agent This is available at your authorized dealer. The instructions for use you'll find on the agent. Daily cleaning is recommended.

14. Switching off the IMPRESSA E80/85

- **DISPLAY** READY
- Switch off your IMPRESSA E80/85 using the ON/OFF key  (8).
- **DISPLAY** RINSE
- An automatic rinsing operation is started.

15. Programming



When your IMPRESSA E80/85 leaves the factory it is adjusted such that you can draw off coffee without having to change any settings. However, you can programme various parameters individually.

You can programme the following stages:

- Filter
- Hardness
- Aroma
- Auto-off

- Stats
- Language
- ML / OZ
- Rinse

➔ Programming key (3)

Use the programming key  (3) to open or quit the programming mode (no saving of values effected).

➔ Rotary Switch (1)

Turn the Rotary Switch (1) to change the adjusted values or to select the next programming step.

Press the Rotary Switch (1) to check the values adjusted or to save the values selected

15.1 Programming the filter

Refer to Chapter 5.1 «Installing the filter».

15.2 Programming the water hardness

Refer to Chapter 4 «Adjusting the water hardness».

15.3 Programming the aroma STANDARD or ROBUST

➔ When the machine leaves the factory, the aroma is set to robust. If requested it can also be set to Standard.

- **DISPLAY** READY
- Press programming key  (3) until **DISPLAY** FILTER – is displayed.
- The illuminated ring (2) is active.
- Turn the Rotary Switch (1) until Aroma is displayed.
- **DISPLAY** AROMA
- Press the Rotary Switch (1).
- **DISPLAY** ROBUST

- Turn the Rotary Switch (1) until the following message is displayed:
- **DISPLAY** STANDARD
- To confirm the new aroma settings, press the Rotary Switch (1).
- **DISPLAY** AROMA
- Press the programming key  (3) to quit the programming mode or select the next programming item using the Rotary Switch (1).
- **DISPLAY** READY

15.4 Programming the automatic switch-off time

➔ You can programme your IMPRESSA E80/85 such that it will switch off automatically after a certain time. You can programme the switch-off time in a range between 0.5 and 9 hours, or select —:— (i.e. inactive).

- **DISPLAY** READY
- Press programming key  (3) until **DISPLAY** FILTER is displayed.
- The illuminated ring (2) is active.
- Turn the Rotary Switch (1) until AUTO OFF is displayed.
- **DISPLAY** AUTO OFF
- Now press the Rotary Switch (1) to start programming the switch-off time. Switch-off time AUTO OFF ...HRS
- **DISPLAY** 5.0 HRS
- Turn the Rotary Switch (1) to adjust the hours.
- **DISPLAY** 1.0 HRS
- To confirm the new switch-off time, press the Rotary Switch (1).
- **DISPLAY** AUTO OFF

- Press the programming key **[P]** (3) to quit the programming mode or select the next programming item using the Rotary Switch (1).
- **DISPLAY** READY

15.5 Cup counter

You can check how many cups of the following coffee products were drawn off:

- 1 cup
- 2 cups
- Powder coffee

- **DISPLAY** READY
- Press programming key **[P]** (3) until **DISPLAY** FILTER – is displayed.
- The illuminated ring (2) is active.
- Turn the Rotary Switch (1) until **STATS** is displayed.
- **DISPLAY** **STATS**
- Now press the Rotary Switch (1) to start programming the item **STATS**
- The total number of drawn off products is displayed.
- For example: **DISPLAY** 100
- Press one of the draw-off keys to learn the number of draw-off operations for the individual products (1 cup **[D]**, 2 cups **[2D]**, **POWDER**)
- For example, press draw-off key for 1 cup **[D]** **DISPLAY** 20
- To quit, press the Rotary Switch (1).
- **DISPLAY** **STATS**
- Press the programming key **[P]** (3) to quit the programming mode or select the next programming item using the Rotary Switch (1).
- **DISPLAY** READY

15.6 Programming the language

- **DISPLAY** READY
- Press programming key **[P]** (3) until **DISPLAY** FILTER is displayed.
- The illuminated ring (2) is active.
- Turn the Rotary Switch (1) until **LANGUAGE** is displayed.
- **DISPLAY** **LANGUAGE**
- Now press the Rotary Switch (1) to start programming the switch-off time. **LANGUAGE**
- Turn the Rotary Switch (1) until the required language is displayed.
- For example **DISPLAY** **ENGLISH**
- Press the Rotary Switch (1) to save the selected language
- **DISPLAY** **LANGUAGE**
- Press the programming key **[P]** (3) to quit the programming mode or select the next programming item using the Rotary Switch (1).
- **DISPLAY** READY

15.7 Milliliters/Ounces

When your IMPRESSA E80/85 leaves the factory, it is set to ML. You can change this setting to OZ.

- **DISPLAY** READY
- Press programming key **[P]** (3) until **DISPLAY** FILTER is displayed.
- The illuminated ring (2) is active.
- Turn the Rotary Switch until “ML / OZ” is displayed.
- **DISPLAY** ML / OZ
- Press the Rotary Switch (1)



- **DISPLAY** ML
- Turn the Rotary Switch (1) until the message OZ is displayed.
- To confirm the new setting, press the Rotary Switch (1)
- **DISPLAY** OZ
- Press the programming key  (3) to quit the programming mode or select the next programming item using the Rotary Switch (1)
- **DISPLAY** READY

15.8 Switch-off rinsing operation

The switch-off rinsing operation of your IMPRESSA E80/85 is activated when the machine leaves the factory. In special cases it can be deactivated. For more information, contact your local customer service.

16. Maintenance

16.1 Filling in water

- **DISPLAY** FILL
WATER
-  If this information is displayed, drawing off products is no longer possible. Refill water as described in Chapter 2.3.
- **DISPLAY** READY
-  The water tank should be rinsed daily and refilled with fresh water. Only fill in fresh, cold water. Never fill in milk, mineral water with gas or other liquids.



16.2 Emptying the coffee grounds container

- **DISPLAY** EMPTY
GROUND
-  If this message appears on the display, you can no longer draw off coffee. You must empty the coffee grounds container first (Fig. 14).
- Carefully take out the drip tray (21), it is filled with water.
 - **DISPLAY** DRAWER
MISSING
 - Insert the empty and clean trip tray again.
 - **DISPLAY** READY

16.3 Drawer missing

- **DISPLAY** DRAWER
MISSING
- If this information is displayed, the drip tray (21) is not installed properly or was not installed at all.
- Insert the drip tray (21).
- **DISPLAY** READY

16.4 Fill coffee beans

- **DISPLAY** FILL
BEANS
 - Refill beans as described in Chapter 2.4.
-  The message FILL BEANS will disappear after you draw off your next cup of coffee.
-  We recommend that you clean the bean tank regularly before refilling beans, using a dry cloth. Before cleaning the tank, switch off the IMPRESSA E80/85.

16.5 Replacing the filter

- ➔ After drawing off 50 litres, the filter cartridge will be used up. A message requesting you to replace the filter will appear on the display.

Refer to Chapter 5.2 «Replacing the filter».

16.6 General cleaning instructions

- Never use scratching objects, pan cleaners, cleaning sponges or caustic chemicals to clean the machine.
 - Wipe off the case on the inside and outside using a soft, moist cloth.
 - Clean the replaceable hot water jet after each use.
 - After heating milk, draw off some hot water, to clean the inside of the replaceable 2-stage frothing jet, too (Fig. 18).
 - Disassemble the 2-stage frothing jet for proper cleaning (Fig. 18).
 - The water tank should be rinsed daily and refilled with fresh water.
- ➔ If the water tank shows signs of scaling, remove the scaling using a commercial de-scaling agent. Take out the water tank (Fig. 4).
 - ➔ Remove the CLARIS plus filter cartridge, if installed, before de-scaling the water tank.

16.7 Emptying the system

IMPRESSA E80/85 **switched off**



- ➔ This operation is required to protect the IMPRESSA E80/85 against frost damage during transports.

- Place a container under the replaceable hot water nozzle (17).
- Press the steam preselection key  (7) until the following message is displayed:
 - **DISPLAY** OPEN TAP
 - **DISPLAY** EMPTYING
 - **DISPLAY** SHUT TAP
- The IMPRESSA E80/85 is switched off.

17. Cleaning the IMPRESSA E80/85 upon display request

- ➔ After 200 draw-off operations or after 80 switch-on rinsing operations, the IMPRESSA E80/85 must be cleaned. A message appears on the display, telling you to start the cleaning programme. You can still draw off coffee or hot water/steam. However, we recommend that you should clean the machine (chapter 17) within the next few days.
- ! JURA cleaning tablets which are specially designed for the cleaning program of your IMPRESSA E80/85 are available at your authorized dealer. Please note that machine defects or residues in the water cannot be excluded if you use inappropriate cleaning agents.
- ➔ Once started, the cleaning operation must not be interrupted.
- ! After each cleaning operation the filler funnel for pre-ground coffee should be cleaned (12).

- **DISPLAY** CLEAN MACHINE / MACHINE READY
- Press the maintenance key  (9).
- **DISPLAY** EMPTY
DRAWER

- Empty the drawer
- **DISPLAY** DRAWER MISSING
- Insert the drawer again.
- Remove the drip grate (20).
- Put a container (1/2 l, Fig. 12) under the adjustable coffee spout (18).
- **DISPLAY** PRESS RINSE
- Press the maintenance key  (9).
- **DISPLAY** CLEANING
- **DISPLAY** ADD TABLET
- Fill in the tablet (see Fig. 15)
- **DISPLAY** PRESS RINSE
- Press the maintenance key  (9).
- **DISPLAY** CLEANING
- **DISPLAY** EMPTY DRAWER
- **DISPLAY** DRAWER MISSING
- **DISPLAY** READY
- The cleaning operation was completed successfully.

17.1 Cleaning the IMPRESSA E80/85 without display request

- Press the maintenance key  (9) until **DISPLAY** RINSE is displayed
- Turn the Rotary Switch (1) until **DISPLAY** CLEANING is displayed

- Press the Rotary Switch (1)
- Now, the program “Replacing the filter” is activated. Now, proceed as described in Chapter 17 as from **DISPLAY** EMPTY DRAWER.

18. De-scaling the IMPRESSA E80/85 upon display request

 During operation, your IMPRESSA E80/85 will calcify. The degree of scaling depends on the hardness of the water in your region. Your Die IMPRESSA E80/85 will inform you when de-scaling is required. You can still draw off coffee or hot water/steam. However, we recommend that you should de-scale the machine (Chapter 18) within the next few days.

 JURA de-scaling tablets which are specially designed for the de-scaling program of your IMPRESSA E80/85 are available at your authorized dealer. Please note that machine defects or residues in the water cannot be excluded if you use inappropriate de-scaling agents.

 If the IMPRESSA E80/85 needs de-scaling, the corresponding message is displayed. You can still draw off coffee or hot water/steam and start the de-scaling program later.

 When using the de-scaling agent, immediately remove any splashes or drips from sensitive surfaces, i.e. natural stone and wooden surfaces, or take appropriate precautions.

 In any case wait until the de-scaling agent is used up and the tank is empty. Never refill de-scaling agent.

- **DISPLAY** DESCALE MACHINE / MACHINE READY
- Press the maintenance key  (9).

- **DISPLAY** EMPTY
DRAWER
- Empty the drawer
- **DISPLAY** DRAWER
MISSING
- Insert the drawer again.
- **DISPLAY** SOLVENT
IN TANK

Completely dissolve the content of one blister (3 tablets) in a jug containing 0.5 litres of water, and fill the mixture in the water tank. Reinstall the water tank.

- **DISPLAY** SOLVENT
IN TANK
OPEN TAP
- Put a sufficiently large container under the replaceable hot water nozzle (17).
- Open the steam / hot water draw-off valve (15) (Fig. 13)
- **DISPLAY** DECAL ON
- **DISPLAY** SHUT TAP
- Close the steam / hot water draw-off valve (15).
- **DISPLAY** DECAL ON
- **DISPLAY** EMPTY
DRAWER
- Empty the drawer
- **DISPLAY** DRAWER
MISSING
- Insert the drawer again.
- **DISPLAY** FILL
WATER

 Rinse the water tank thoroughly and fill it with cold, fresh tap water. Install it again.

- **DISPLAY** OPEN TAP
- Open the steam / hot water draw-off valve (15) (Fig. 13)
- **DISPLAY** DECAL ON
- **DISPLAY** SHUT TAP
- After you have closed the steam / hot water draw off tap (15), the following message is displayed
- **DISPLAY** DECAL ON
- **DISPLAY** EMPTY
DRAWER
- Empty the drawer
- **DISPLAY** DRAWER
MISSING
- Insert the drawer again.
- **DISPLAY** PRESS
RINSE
- Press the maintenance key  (9).
- **DISPLAY** RINSE
- **DISPLAY** READY
- The de-scaling operation was completed successfully.

18.1 De-scaling the IMPRESSA E80/85 without display request

- Press the maintenance key  (9) until **DISPLAY** RINSE is displayed
- Turn the Rotary Switch (1) until **DISPLAY** DECAL ON is displayed
- Press the Rotary Switch (1)
- Now, the “De-scaling” program is activated. Now, proceed as described in Chapter 18 as from **DISPLAY** EMPTY DRAWER.

19. Disposal

Please return the IMPRESSA E80/85 machine to your local dealer, the service shop or to JURA for proper disposal.

20. Tips for perfect coffee

Height-adjustable coffee spout (18)

You can adjust the height of the coffee spout to the size of your cups (Fig. 3)

Grinding degree

Refer to Chapter 2.5 «Adjusting the grinding gear».

Preheating cups

You can preheat the cups using hot water or steam. The smaller the coffee you want to draw off, the more important preheating is.

Sugar and cream

Stirring coffee/tea will result in heat being released. Adding refrigerated cream or milk will reduce the temperature of the coffee significantly.

21. Messages

DISPLAY	Cause	Remedy
FILL WATER	Water tank is empty.	Refill water
	Float defective	Rinse or de-scale water tank
FILL BEANS	Bean tank is empty.	Refill beans
	Although you have refilled beans, the message still appears.	Draw off a cup of coffee. The message will disappear only after you have drawn off a cup of coffee
EMPTY GROUNDS	Coffee grounds container full	Empty coffee grounds container
	Tray reinstalled too early after emptying	Wait 10 sec. before reinstalling the tray
DRAWER MISSING	Drip tray not installed properly or missing	Install tray properly
CLEAN MACHINE / MACHINE READY	Cleaning required	Start cleaning programme (chapter 17)
DESCALE MACHINE / MACHINE READY	De-scaling required	Start de-scaling programme (chapter 18)
CHANGE FILTER / MACHINE READY	Filter used up	Replace filter (chapter 5.2)
ERROR	General fault	<ul style="list-style-type: none">- switch off- disconnect from mains supply- Connect IMPRESSA E80/85 to power supply- Switch on IMPRESSA E80/85 <ul style="list-style-type: none">- Have IMPRESSA E80/85 checked by JURA Service

22. Problems

Problem	Cause	Remedy
Very loud noise coming from the grinding gear	Foreign body in grinding gear	Drawing off pre-ground coffee still possible Have IMPRESSA E80/85 checked by JURA Service
Too little froth when frothing milk	2-stage frothing jet blocked	clean 2-stage frothing jet (Chapter 12)
	2-stage frothing jet in wrong position	Draw off steam (Chapter 12)
Coffee only drips from the coffee spout	Grinding degree too fine	Coarser grinding gear adjustment
	Pre-ground coffee too fine	Use a coarser pre-ground coffee

High-frequency, electromagnetic interference may influence the display. Drawing off coffee is possible at any time.

If the messages or problems still persist, please contact your local authorized dealer or JURA Elektroapparate AG.

23. Legal information

These operating instructions contain all the information required for using, operating and maintaining the machine properly.

Knowledge of and compliance with the specifications contained in these operating instructions is required for using the machine safely as well as for operational safety and safety during maintenance.

These operating instructions cannot cover any conceivable application. The machine was designed for private household use.

Additionally we point out that the content of these operating instructions does not form part of any previous or existing agreement, consent or al legal relationship nor does it constitute a change of such an agreement, consent or legal relationship. Any obligations to be fulfilled by JURA Elektroapparate AG are stipulated in the corresponding purchase contract, which also contains the full and solely applicable warranty stipulations. These contractual warranty stipulations are neither extended nor limited by the specifications contained in these operating instructions.

The operating instructions contain information, protected by Copyright. Photocopying or translations into other languages shall not be permissible without JURA Elektroapparate AG's written approval.

24. Technical data

Voltage:	230V AC
Power:	1450 W
Fuse:	10 A
Safety check:	
Energy consumption standby:	approx. 2.6 Wh
Energy consumption "ready for draw-off" mode:	approx. 11 Wh
Pump pressure:	static max. 15 bar
Water tank:	1,9 Liter
Beantank capacity:	200gr.
Coffee grounds container capacity :	max. 16 portions
Length of cable:	approx. 1,1 m
Weight:	8.6 kg
Size (WxHxD):	28x34.5x42 cm

The machine complies with the following EU directives:

73/23/EEG dated 19/02/1973 "Low Voltage Directive" including Modification Directive 93/336/EEG

89/336/EEG dated 03/05/1989 "EMC Directive" including Modification Directive 92/31/EEG